

Article number: 03504090

Description: Fluro Rod end GE 90LO

Measures

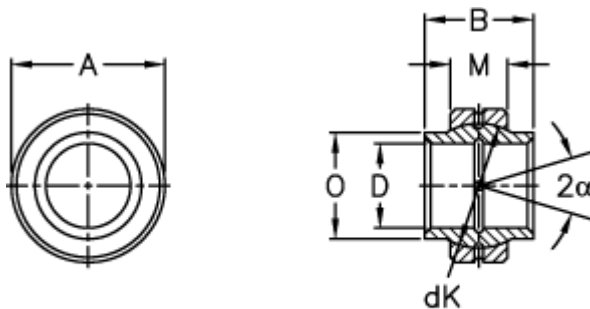

Str. 12 den smørerille

A	= 130 0 -0,018	Tilt angle = 4
B	= 90	Weight = 3000
D	= 90 0 +0,035	
dK	= 115	
Dynamic load C (kN)	= 490	
M	= 50	
O	= 99	
Static load C0 (kN)	= 2450	